

MSC2020: 05C78, 05C15

© *R. Shankar, M. Ch. Nalliah*

LOCAL ANTIMAGIC CHROMATIC NUMBER FOR THE CORONA PRODUCT OF WHEEL AND NULL GRAPHS

Let $G = (V, E)$ be a graph of order p and size q having no isolated vertices. A bijection $f: E \rightarrow \{1, 2, 3, \dots, q\}$ is called a local antimagic labeling if for all $uv \in E$, we have $w(u) \neq w(v)$, the weight $w(u) = \sum_{e \in E(u)} f(e)$, where $E(u)$ is the set of edges incident to u . A graph G is local antimagic, if G has a local antimagic labeling. The local antimagic chromatic number $\chi_{la}(G)$ is defined to be the minimum number of colors taken over all colorings of G induced by local antimagic labelings of G . In this paper, we completely determine the local antimagic chromatic number for the corona product of wheel and null graphs.

Keywords: local antimagic labeling, local antimagic chromatic number, corona product, wheel graph.

DOI: [10.35634/vm220308](https://doi.org/10.35634/vm220308)

Introduction

We only consider finite, undirected graph $G = (V, E)$ without loops nor multiple edges. The order and size of G are denoted by $|V| = p$ and $|E| = q$, respectively. For graph-theoretic terminology, we refer to Chartrand and Lesniak [4].

For a graph G , let $f: E \rightarrow \{1, 2, \dots, q\}$ be a bijection. For each vertex $u \in V(G)$, the weight $w(u) = \sum_{e \in E(u)} f(e)$, where $E(u)$ is the set of edges incident to u . If $w(u) \neq w(v)$ for any two distinct vertices u and $v \in V(G)$, then f is called an antimagic labeling of G . A graph G is called antimagic if G has an antimagic labeling. This concept was introduced by Hartsfield and Ringel's [7]. They conjectured that every connected graph with at least three vertices admits an antimagic labeling [7]. They also made a weak conjecture that every tree with at least three vertices admits an antimagic labeling. These two conjectures were partially shown to be true by several authors, but they are still unsolved. For the best and most interesting results that were obtained so far, one can see [5, 12]. For a detailed and interesting review of these conjectures, one can see [6, Chapter 6].

Arumugam, Premalatha, Bacă, and Andrea Semaničová-Fecňovčíková in [1], and independently, Bensmail, Senhaji, and Lyngsie in [3], posed a new definition as a relaxation of the notion of antimagic labeling. They called a bijection $f: E \rightarrow \{1, 2, \dots, q\}$ a *local antimagic labeling* of G if for any two adjacent vertices u and v in $V(G)$, we have $w(u) \neq w(v)$. They conjectured that every connected graph with at least three vertices admits a local antimagic labeling. This conjecture was solved partially in [3]. Finally, Haslegrave proved this conjecture through probabilistic tools [8].

Since every local antimagic labeling f of a graph G corresponds to a proper vertex coloring of G , the *local antimagic chromatic number* of G , denoted $\chi_{la}(G)$, is defined to be the minimum number of colors taken over all colorings of G induced by any local antimagic labelings of G [1].

Let G_1 and G_2 be two vertex disjoint graphs. The *join graph* of G_1 and G_2 , denoted by $G_1 \vee G_2$, is the graph whose vertex set is $V(G_1) \cup V(G_2)$ and its edge set equals $E(G_1) \cup E(G_2) \cup \{ab: a \in V(G_1) \text{ and } b \in V(G_2)\}$. Arumugam et al. [1], Shaebani [14] and Lau et al. [9], studied independently, the local antimagic chromatic number of $G_1 \vee O_m$ for $m \geq 2$. Arumugam et al. [1] and Lau et al. [9] also proved that for a wheel graph W_n of $n + 1$ vertices, $\chi_{la}(W_n) = 3$ if n is

even, and 4 if n is odd. Lau et al. [10] also obtained the local antimagic chromatic number of a fan graph, F_n , and $W_n - e$, a wheel graph with a spoke deleted.

The corona product of G and H , denoted $G \circ H$, is obtained from G and $|V(G)|$ copies of H by joining the i -th vertex of G to every vertex of the i -th copy of H , $i = 1, 2, 3, \dots, |V(G)|$, see in [2]. In Arumugam et al. [2], the authors obtained the local antimagic chromatic number for the corona product graph $G \circ O_m$, where $G = P_n, C_n$ and K_n .

Motivated by this, in this paper, we study the local antimagic chromatic number for the corona product of $W_n \circ O_m$.

§ 1. $\chi_{la}(W_n \circ O_m)$, n is even

Let c be the central vertex and $v_i, 1 \leq i \leq n$ be the vertices on the cycle of W_n . Let u_i^k be the k -th vertex of the i -th copy of O_m adjacent to $v_i, 1 \leq i \leq n$, and let u^k be the k -th vertex of the (n_1) -st copy of O_m adjacent to $c, 1 \leq k \leq m$.

Lemma 1. For $n \geq 4$ is even and $m \geq 1$ we have $\chi_{la}(W_n \circ O_m) \geq m(n+1) + 3$.

P r o o f. Let $G = W_n \circ O_m$. For $1 \leq i \leq n, 1 \leq k \leq m$, let $V(W_n \circ O_m) = \{c, v_i, u_i^k, u^k\}$ and $E(W_n \circ O_m) = \{cv_i, v_i u_i^k, cu^k, v_i v_{i+1}\}$ where $v_{n+1} = v_1$. Clearly, $|V(W_n \circ O_m)| = (n+1)(m+1)$ and $|E(W_n \circ O_m)| = 2n + m(n+1) = q$.

Let f be a local antimagic labeling of G . We first observe that $w(u_i^k) = f(v_i u_i^k), w(u^k) = f(cu^k)$ are mutually distinct and at most q . Thus, f must induce $m(n+1)$ distinct colors, namely $w_1, w_2, \dots, w_{m(n+1)}$.

The minimum possible weight of the central vertex c is $w(c) \geq \frac{(m+n)(m+n+1)}{2} > q$ and hence the central vertex c receives a new color $w_{m(n+1)+1}$.

Without loss of generality, we consider the following three cases.

Case 1. $f(v_1 v_2) = q$. In this case, $w(v_1), w(v_2) > q$ and $w(u_i^k) < q$ for $1 \leq i \leq n, 1 \leq k \leq m$. Since $w(v_1) \neq w(v_2) \neq w(c)$, v_1 and v_2 receive new colors, say $w_{m(n+1)+2}$ and $w_{m(n+1)+3}$. Therefore, $\chi_{la}(G) \geq m(n+1) + 3$.

Case 2. $f(v_1 u_1^1) = q$. Now, $w(v_1) > q \neq w(c)$ so that v_1 receives a new color, say $w_{m(n+1)+2}$. Therefore, $\chi_{la}(G) \geq m(n+1) + 2$. Suppose equality holds. We must have $w(v_2), w(v_n) \leq q$. Moreover, $w(v_i)$ ($2 \leq i \leq n$) equals to a non-adjacent pendant vertex label, or else, $w(v_i) = w(v_1)$ for $3 \leq i \leq n-1$ such that for $3 \leq i \leq n-2$, not both $w(v_i)$ and $w(v_{i+1}) > q$, otherwise, f induces $m(n+1) + 3$ distinct colors. Let r be the number of vertices in $\{v_i: 1 \leq i \leq n\}$ with color $w(v_1)$. Observe that there are $n-r \geq n/2 \geq 2$ vertices with color at most q . Note that all these $n-r$ vertices are incident to $(m+2)n-r(m+1) = (m+1)(n-r) + n$ edges. Therefore, their labels sum under f is at most $(n-r)q$. However, the sum is at least $S = 1 + 2 + \dots + [(m+1)(n-r) + n] = \frac{1}{2}[(m+1)(n-r) + n][(m+1)(n-r) + n + 1]$. Now,

$$\begin{aligned} 2S - 2(n-r)q &= [(m+1)(n-r) + n]^2 + [(m+1)(n-r) + n] - 2(n-r)[m(n+1) + 2n] \\ &= (m+1)^2(n-r)^2 + n^2 + (m+1)(n-r)(2n+1) + n - 2(n-r)(mn+m+2n) \\ &= (m+1)^2(n-r)^2 + n^2 - (n-r)(m+2n-1) > 0, \end{aligned}$$

contradicting $S \leq (n-r)q$. Thus, $\chi_{la}(G) \geq m(n+1) + 3$.

Case 3. $f(cv_1) = q$. Now, $w(v_1) > q \neq w(c)$ so that v_1 receives a new color, say $w_{m(n+1)+2}$. Therefore, $\chi_{la}(G) \geq m(n+1) + 2$. Suppose equality holds. We must have $w(v_2), w(v_n) < q$.

By an argument similar to that in Case 2, we also reach the same contradiction. Thus, $\chi_{la}(G) \geq m(n+1) + 3$. The proof is complete. \square

Throughout this paper, each algebraic formula F will be associated with its so-called c -set. This is the set of all values that F can take.

Theorem 1. For $n \geq 4$ is even and $m \geq 1$, $\chi_{la}(W_n \circ O_m) = m(n + 1) + 3$.

P r o o f. Let $G = W_n \circ O_m$ with $V(G)$ and $E(G)$ as defined in Lemma 1. We shall show that $\chi_{la}(W_n \circ O_m) \leq m(n + 1) + 3$. Define a bijection $f: E(G) \rightarrow \{1, 2, 3, \dots, q = 2n + m(n + 1)\}$ as follows.

Case (1): $m = 1$.

Subcase (i): $n = 4$. Define $f(cv_1) = 3; f(cv_2) = 2; f(cv_3) = 4; f(cv_4) = 1; f(v_1v_2) = 6; f(v_2v_3) = 8; f(v_3v_4) = 7; f(v_4v_1) = 9; f(v_1u_1^1) = 13; f(v_2u_2^1) = 11; f(v_3u_3^1) = 12; f(v_4u_4^1) = 10; f(cu^1) = 5$. The vertex weights are $w(c) = 15; w(v_1) = w(v_3) = 31; w(v_2) = w(v_4) = 27; w(u_i^1) = f(v_iu_i^1), i = 1, 2, 3, 4$ and $w(u^1) = 5$.

Hence, $\chi_{la}(W_4 \circ O_1) \leq 8$.

Subcase (ii): $n \geq 6$. Define

$$f(cv_i) = \begin{cases} \frac{n+2}{2}, & i = 1, \\ \frac{2n-i+3}{2}, & i > 1 \text{ is odd,} \\ \frac{n-i+2}{2}, & i \text{ is even,} \end{cases}$$

$$f(v_i v_{i+1}) = \begin{cases} \frac{2n+i+3}{2}, & 1 \leq i < n \text{ is odd,} \\ \frac{3n+i+2}{2}, & 1 < i \leq n \text{ is even,} \end{cases}$$

$$f(v_n v_1) = 2n + 1$$

$$f(v_i u_i^1) = \begin{cases} \frac{6n-i+3}{2}, & i \text{ is odd,} \\ \frac{5n+4-i}{2}, & i \text{ is even,} \end{cases}$$

$$f(cu^1) = n + 1.$$

The vertex weights are

$$w(c) = \frac{(n+1)(n+2)}{2},$$

$$w(u_i^1) = 2n + 1 + i, \quad 1 \leq i \leq n,$$

$$w(u^1) = n + 1,$$

$$w(v_i) = \begin{cases} \frac{13n+10}{2}, & i \text{ is odd,} \\ \frac{11n+10}{2}, & i \text{ is even.} \end{cases}$$

Hence, $\chi_{la}(W_n \circ O_1) \leq n + 4$.

Case (2): $m = 2$.

Subcase (i): $n = 4$. Define

$$f(cv_i) = 5 - i, \quad 1 \leq i \leq n,$$

$$f(v_i v_{i+1}) = 7 + i, \quad 1 \leq i \leq n - 1,$$

$$f(v_n v_1) = 7,$$

$$f(v_i u_i^k) = \begin{cases} \frac{37-i}{2}, & k=1, \quad i=1,3, \\ \frac{33-i}{2}, & k=2, \quad i=1,3, \\ \frac{20+i}{2}, & k=1, \quad i=2,4, \\ \frac{24+i}{2}, & k=2, \quad i=2,4, \end{cases}$$

$$f(cu^k) = 4+k, \quad 1 \leq k \leq 2.$$

The vertex weights are

$$w(c) = 21, \quad w(v_i) = \begin{cases} 53, & i=1,3, \\ 44, & i=2,4, \end{cases} \quad w(u_i^k) = f(v_i u_i^k), \quad w(u^k) = f(cu^k).$$

Hence, $\chi_{la}(W_4 \circ O_2) \leq 13$.

Subcase (ii): $n \geq 6$.

$$f(v_i u_i^k) = \begin{cases} \frac{7n-i+5}{2}, & k=1, \quad i \text{ is odd}; \\ \frac{8n-i+5}{2}, & k=2, \quad i \text{ is odd}; \\ \frac{5n+4-i}{2}, & k=1, \quad i \text{ is even}, \quad 1 \leq i \leq n-2; \\ \frac{6n+4-i}{2}, & k=2, \quad i \text{ is even}, \quad 1 \leq i \leq n-2; \\ \frac{5n+4}{2}, & k=1, \quad i=n, \\ \frac{6n+4}{2}, & k=2, \quad i=n, \end{cases}$$

$$f(cv_i) = n-i+1, \quad 1 \leq i \leq n; \quad \text{c-set } \{n, n-1, \dots, 2, 1\},$$

$$f(v_i v_{i+1}) = n+3+i, \quad 1 \leq i \leq n-1; \quad \text{c-set } \{n+4, n+5, \dots, 2n+1, 2n+2\},$$

$$f(v_n v_1) = n+3,$$

$$f(cu^k) = n+k, \quad 1 \leq k \leq 2; \quad \text{c-set } \{n+1, n+2\}.$$

The vertex weights are

$$w(c) = \frac{(n+2)(n+3)}{2},$$

$$w(u_i^k) = f(v_i u_i^k), \quad 1 \leq i \leq n, \quad 1 \leq k \leq 2,$$

$$w(u^k) = f(cu^k),$$

$$w(v_i) = \begin{cases} \frac{21n+22}{2}, & i \text{ is odd}, \quad 1 \leq i \leq n-1, \\ \frac{17n+20}{2}, & i \text{ is even}, \quad 2 \leq i \leq n. \end{cases}$$

Hence, $\chi_{la}(W_n \circ O_2) \leq 2n + 5$.

Case (3): $m \geq 3$.

Subcase (i): m is odd, $m \geq 3$. Define

$$\begin{aligned}
 f(cv_i) &= \begin{cases} \frac{n}{2} + 1, & i = 1, \\ \frac{2n - i + 3}{2}, & i > 1 \text{ is odd; c-set } \left\{ n, n - 1, n - 2, \dots, \frac{n}{2} + 2 \right\}, \\ \frac{n - i + 2}{2}, & i \text{ is even; c-set } \left\{ \frac{n}{2}, \frac{n}{2} - 1, \frac{n}{2} - 2, \dots, 2, 1 \right\}, \end{cases} \\
 f(v_i v_{i+1}) &= \begin{cases} \frac{2n + i + 3}{2}, & 1 \leq i \leq n - 1 \text{ is odd; c-set } \left\{ n + 2, n + 3, n + 4, \dots, \frac{3n}{2}, \frac{3n}{2} + 1 \right\}, \\ \frac{3n + i + 2}{2}, & 2 \leq i \leq n - 2 \text{ is even; c-set } \left\{ \frac{3n}{2} + 2, \frac{3n}{2} + 3, \frac{3n}{2} + 4, \dots, 2n - 1, 2n \right\}, \end{cases} \\
 f(v_n v_1) &= 2n + 1, \\
 f(v_i u_i^k) &= \begin{cases} \frac{6n - i + 3}{2}, & i \text{ is odd, } k = 1; \\ & \text{c-set } \left\{ 3n + 1, 3n, 3n - 1, \dots, \frac{5n}{2} + 3, \frac{5n}{2} + 2 \right\}, \\ \frac{5n + 4 - i}{2}, & i \text{ is even, } k = 1; \\ & \text{c-set } \left\{ \frac{5n}{2} + 1, \frac{5n}{2}, \frac{5n}{2} - 1, \dots, 2n + 3, 2n + 2 \right\}, \\ \frac{n(k + 4) + i + 3}{2}, & i \text{ is odd, } k \text{ is even, } 1 \leq i \leq n - 1, \quad 2 \leq k \leq m - 1; \\ & \text{c-set is given in Table 1,} \\ \frac{n(k + 5) - i + 3}{2}, & i \text{ is odd, } k \text{ is odd, } 1 \leq i \leq n - 1, \quad 3 \leq k \leq m; \\ & \text{c-set is given in Table 2,} \\ \frac{n(m + k + 3) + i + 2}{2}, & i \text{ is even, } k \text{ is even, } 2 \leq i \leq n, \quad 2 \leq k \leq m - 1; \\ & \text{c-set is given in Table 3,} \\ \frac{n(m + k + 4) - i + 4}{2}, & i \text{ is even, } k \text{ is odd, } 2 \leq i \leq n, \quad 3 \leq k \leq m; \\ & \text{c-set is given in Table 4,} \end{cases} \\
 f(cu^k) &= \begin{cases} n + 1, & k = 1, \\ n(m + 2) + k, & 2 \leq k \leq m; \\ & \text{c-set } \{n(m + 2) + 2, n(m + 2) + 3, \dots, n(m + 2) + m\}. \end{cases}
 \end{aligned}$$

Table 1: n is even, i is odd, $1 \leq i \leq n$, m is odd, k is even, $2 \leq k \leq m - 1$

$v_1 u_1^k$	$v_3 u_3^k$...	$v_{n-3} u_{n-3}^k$	$v_{n-1} u_{n-1}^k$	k
$3n + 2$	$3n + 3$...	$\frac{7n}{2}$	$\frac{7n}{2} + 1$	2
$4n + 2$	$4n + 3$...	$\frac{9n}{2}$	$\frac{9n}{2} + 1$	4
\vdots	\vdots	...	\vdots	\vdots	\vdots
$\frac{n(m+3)}{2} + 2$	$\frac{n(m+3)}{2} + 3$...	$\frac{n(m+4)}{2}$	$\frac{n(m+4)}{2} + 1$	$m - 1$

Table 2: n is even, i is odd, $1 \leq i \leq n$, m is odd, k is odd, $3 \leq k \leq m$

$v_1 u_1^k$	$v_3 u_3^k$...	$v_{n-3} u_{n-3}^k$	$v_{n-1} u_{n-1}^k$	k
$4n + 1$	$4n$...	$\frac{7n}{2} + 3$	$\frac{7n}{2} + 2$	3
$5n + 1$	$5n$...	$\frac{9n}{2} + 3$	$\frac{9n}{2} + 2$	5
\vdots	\vdots	...	\vdots	\vdots	\vdots
$\frac{n(m+5)}{2} + 1$	$\frac{n(m+5)}{2}$...	$\frac{n(m+4)}{2} + 3$	$\frac{n(m+4)}{2} + 2$	m

Table 3: n is even, i is even, $1 \leq i \leq n$, m is odd, k is even, $2 \leq k \leq m - 1$

$v_2 u_2^k$	$v_4 u_4^k$...	$v_{n-2} u_{n-2}^k$	$v_n u_n^k$	k
$\frac{n(m+5)}{2} + 2$	$\frac{n(m+5)}{2} + 3$...	$\frac{n(m+6)}{2}$	$\frac{n(m+6)}{2} + 1$	2
$\frac{n(m+7)}{2} + 2$	$\frac{n(m+7)}{2} + 3$...	$\frac{n(m+8)}{2}$	$\frac{n(m+8)}{2} + 1$	4
\vdots	\vdots	...	\vdots	\vdots	\vdots
$n(m+1) + 2$	$n(m+1) + 3$...	$n(m+1) + \frac{n}{2}$	$n(m+1) + \frac{n}{2} + 1$	$m - 1$

Table 4: n is even, i is even, $1 \leq i \leq n$, m is odd, k is odd, $3 \leq k \leq m$

$v_2 u_2^k$	$v_4 u_4^k$...	$v_{n-2} u_{n-2}^k$	$v_n u_n^k$	k
$\frac{n(m+7)}{2} + 1$	$\frac{n(m+7)}{2}$...	$\frac{n(m+6)}{2} + 3$	$\frac{n(m+6)}{2} + 2$	3
$\frac{n(m+9)}{2} + 1$	$\frac{n(m+9)}{2}$...	$\frac{n(m+8)}{2} + 3$	$\frac{n(m+8)}{2} + 2$	5
\vdots	\vdots	...	\vdots	\vdots	\vdots
$n(m+2) + 1$	$n(m+2)$...	$n(m+2) - \frac{n}{2} + 3$	$n(m+2) - \frac{n}{2} + 2$	m

Then the vertex weights are

$$\begin{aligned}
 w(c) &= \frac{n(2m^2 + 2m + n - 1) + m(m + 1)}{2}, \quad m \geq 3 \text{ is odd,} \\
 w(u_i^k) &= f(v_i u_i^k), \\
 w(u^k) &= f(cu^k), \\
 w(v_i) &= \begin{cases} \frac{mn(m + 10) + 3(5n + 2m) + 14}{4}, & m \geq 3 \text{ is odd, } i \text{ is odd, } 1 \leq i \leq n - 1, \\ \frac{3mn(m + 2) + 2(3m + 7 + 13n)}{4}, & m \geq 3 \text{ is odd, } i \text{ is even, } 2 \leq i \leq n, \\ \frac{2mn(m + 1) - m(m - 5) + 2(4n + 3)}{2}, & m \geq 3 \text{ is odd, } i = n. \end{cases}
 \end{aligned}$$

Thus, the labeling f admits local antimagic labeling of $W_n \circ O_m$ with $m(n + 1) + 3$ colors.

Subcase (ii): When m is even, $m \geq 4$

$$\begin{aligned}
 f(cv_i) &= n - i + 1, \quad 1 \leq i \leq n; \quad \text{c-set } \{n, n - 1, \dots, 2, 1\}, \\
 f(v_i v_{i+1}) &= n + 3 + i, \quad 1 \leq i \leq n - 1; \quad \text{c-set } \{n + 4, n + 5, \dots, 2n + 1, 2n + 2\}, \\
 f(v_n v_1) &= n + 3, \\
 f(cu^k) &= \begin{cases} n + k, & 1 \leq k \leq 2; \quad \text{c-set } \{n + 1, n + 2\}, \\ n(m + 2) + k, & 3 \leq k \leq m; \\ & \text{c-set } \{n(m + 2) + 3, n(m + 2) + 4, \dots, n(m + 2) + m\}, \end{cases} \\
 f(v_i u_i^k) &= \begin{cases} \frac{7n - i + 5}{2}, & k = 1, \quad i \text{ is odd;} \\ & \text{c-set } \left\{ \frac{7n}{2} + 2, \frac{7n}{2} + 1, \dots, 3n + 4, 3n + 3 \right\}, \\ \frac{8n - i + 5}{2}, & k = 2, \quad i \text{ is odd;} \\ & \text{c-set } \left\{ 4n + 2, 4n + 1, \dots, \frac{7n}{2} + 4, \frac{7n}{2} + 3 \right\}, \\ \frac{5n + 4 - i}{2}, & k = 1, \quad i \text{ is even;} \\ & \text{c-set } \left\{ \frac{5n}{2} + 1, \frac{5n}{2}, \dots, 2n + 4, 2n + 3 \right\}, \\ \frac{6n + 4 - i}{2}, & k = 2, \quad i \text{ is even;} \\ & \text{c-set } \left\{ 3n + 1, 3n, \dots, \frac{5n}{2} + 4, \frac{5n}{2} + 3 \right\}, \\ \frac{5n}{2} + 2, & k = 1, \quad i = n, \\ 3n + 2, & k = 2, \quad i = n, \\ \frac{n(k + 5) + i + 5}{2}, & i \text{ is odd, } k \geq 3 \text{ is odd; c-set is given in Table 5,} \\ \frac{n(k + 6) - i + 5}{2}, & i \text{ is odd, } k \geq 2 \text{ is even; c-set is given in Table 6,} \\ \frac{n(m + k + 3) + i + 4}{2}, & i \geq 2 \text{ is even, } k \geq 3 \text{ is odd; c-set is given in Table 7,} \\ \frac{n(m + k + 4) - i + 6}{2}, & i \geq 2 \text{ is even, } k \geq 4 \text{ is even; c-set is given in Table 8.} \end{cases}
 \end{aligned}$$

Table 5: n is even, i is odd, $1 \leq i \leq n$, $m \geq 4$ is even, k is odd, $3 \leq k \leq m - 1$

$v_1 u_1^k$	$v_3 u_3^k$...	$v_{n-3} u_{n-3}^k$	$v_{n-1} u_{n-1}^k$	k
$4n + 3$	$4n + 4$...	$4n + \frac{n}{2} + 1$	$4n + \frac{n}{2} + 2$	3
$5n + 3$	$5n + 4$...	$5n + \frac{n}{2} + 1$	$5n + \frac{n}{2} + 2$	5
\vdots	\vdots	...	\vdots	\vdots	\vdots
$\frac{n(m+4)}{2} + 3$	$\frac{n(m+4)}{2} + 4$...	$\frac{n(m+5)}{2} + 1$	$\frac{n(m+5)}{2} + 2$	$m - 1$

Table 6: n is even, i is odd, $1 \leq i \leq n$, $m \geq 4$ is even, k is even, $4 \leq k \leq m$

$v_1 u_1^k$	$v_3 u_3^k$...	$v_{n-3} u_{n-3}^k$	$v_{n-1} u_{n-1}^k$	k
$5n + 2$	$5n + 1$...	$4n + \frac{n}{2} + 4$	$4n + \frac{n}{2} + 3$	4
$6n + 2$	$6n + 1$...	$5n + \frac{n}{2} + 4$	$5n + \frac{n}{2} + 3$	6
\vdots	\vdots	...	\vdots	\vdots	\vdots
$\frac{n(m+6)}{2} + 2$	$\frac{n(m+6)}{2} + 1$...	$\frac{n(m+5)}{2} + 4$	$\frac{n(m+5)}{2} + 3$	$m - 1$

Table 7: n is even, i is even, $1 \leq i \leq n$, $m \geq 4$ is even, k is odd, $3 \leq k \leq m - 1$

$v_2 u_2^k$	$v_4 u_4^k$...	$v_{n-2} u_{n-2}^k$	$v_n u_n^k$	k
$\frac{n(m+6)}{2} + 3$	$\frac{n(m+6)}{2} + 4$...	$\frac{n(m+7)}{2} + 1$	$\frac{n(m+7)}{2} + 2$	3
$\frac{n(m+8)}{2} + 3$	$\frac{n(m+8)}{2} + 4$...	$\frac{n(m+9)}{2} + 1$	$\frac{n(m+9)}{2} + 2$	5
\vdots	\vdots	...	\vdots	\vdots	\vdots
$n(m+1) + 3$	$n(m+1) + 4$...	$n(m+1) + 1 + \frac{n}{2}$	$n(m+1) + 2 + \frac{n}{2}$	$m - 1$

Table 8: n is even, i is even, $1 \leq i \leq n$, $m \geq 4$ is even, k is even, $4 \leq k \leq m$

$v_2 u_2^k$	$v_4 u_4^k$...	$v_{n-2} u_{n-2}^k$	$v_n u_n^k$	k
$\frac{n(m+8)}{2} + 2$	$\frac{n(m+8)}{2} + 1$...	$\frac{n(m+7)}{2} + 4$	$\frac{n(m+7)}{2} + 3$	4
$\frac{n(m+10)}{2} + 2$	$\frac{n(m+10)}{2} + 1$...	$\frac{n(m+9)}{2} + 4$	$\frac{n(m+9)}{2} + 3$	5
\vdots	\vdots	...	\vdots	\vdots	\vdots
$n(m+2) + 2$	$n(m+2) + 1$...	$n(m+1) + 4 + \frac{n}{2}$	$n(m+1) + 3 + \frac{n}{2}$	m

Thus, the vertex weights are

$$w(c) = \frac{n(n-3) + m(2mn + m + 1)}{2}, \quad m \geq 4 \text{ is even,}$$

$$w(v_i) = \begin{cases} \frac{mn(m+12) + 2(7n + 5m + 12)}{4}, & m \geq 4 \text{ is even, } i \text{ is odd, } 1 \leq i \leq n-1, \\ \frac{mn(3m+4) + 2(7n + 5m + 10)}{4}, & m \geq 4 \text{ is even, } i \text{ is even, } 2 \leq i \leq n, \end{cases}$$

$$w(u_i^k) = f(v_i u_i^k),$$

$$w(u^k) = f(cu^k).$$

Thus, the labeling f admits local antimagic labeling of $W_n \circ O_m$ with $m(n+1) + 3$ colors, if n is even. Hence, $\chi_{la}(W_n \circ O_m) = m(n+1) + 3$. □

Example 1. Figures 1 and 2 gives the labelings of $W_8 \circ O_3$ and $W_6 \circ O_4$ as in the proof above.

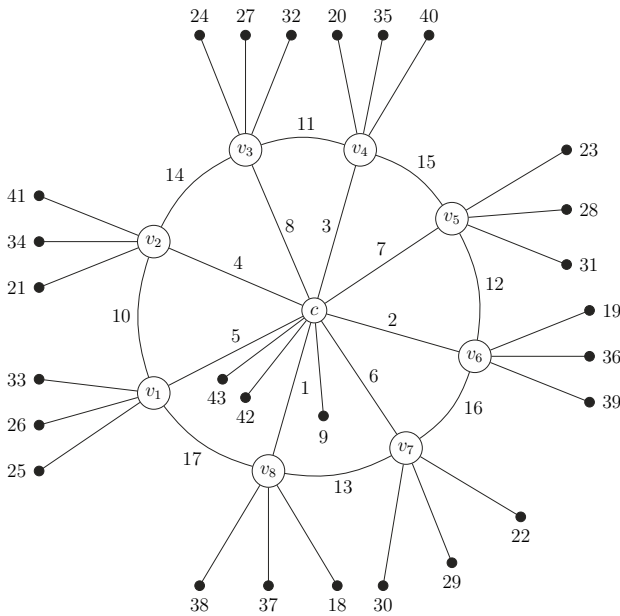

Figure 1: $\chi_{la}(W_8 \circ O_3) = 30$

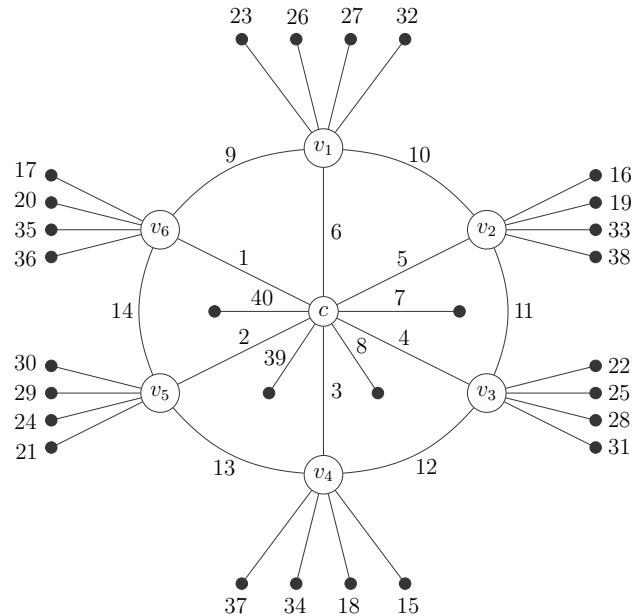

Figure 2: $\chi_{la}(W_6 \circ O_4) = 31$

§ 2. $\chi_{la}(W_n \circ O_m)$, n is odd

Lau et al. [11] investigated the local antimagic chromatic number for a graph $K(m; n_1, n_2, \dots, n_m)$ which is obtained from a complete graph K_m of order m by attaching n_i pendants to the i -th vertex of K_m . Clearly, $K(4; m, m, m, m) = W_3 \circ O_m$ and they proved that $\chi_{la}(K(4; m, m, m, m)) = 4m + 4$ if and only if $m \geq 2$.

Theorem 2. $\chi_{la}(W_3 \circ O_m) = 4m + 4$ if and only if $m \geq 2$. Otherwise, $\chi_{la}(W_3 \circ O_1) = 7$.

P r o o f. By Theorem 3.1 in [11], we only need to consider $G = W_3 \circ O_1$. Since $W_3 = K_4$, we must have $w(c) \neq w(v_1) \neq w(v_2) \neq w(v_3)$ for any local antimagic labeling f of G . Now, $w(c), w(v_i) \geq 10$, and $w(u_i^1) \leq 10, w(u^1) \leq 10$. Thus, at most one vertex $v \in \{c, v_1, v_2, v_3\}$ has $w(v) = 10$. Therefore, $\chi_{la}(W_3 \circ O_1) = 7$. Define $f(v_1 u_1^1) = 1, f(v_2 u_2^1) = 9, f(v_3 u_3^1) = 8, f(cu^1) = 10, f(v_1 v_2) = 2, f(v_2 v_3) = 7, f(v_3 v_1) = 3, f(cv_1) = 4, f(cv_2) = 5, f(cv_3) = 6$, a required local antimagic labeling is obtained. □

Lemma 2. For $n \geq 5$ is odd and $m \geq 1$ we have

$$\chi_{la}(W_n \circ O_m) \geq \begin{cases} m(n+1) + 3, & \text{if } m < 2n - 3, \\ m(n+1) + 4, & \text{otherwise.} \end{cases}$$

Proof. Let $G = W_n \circ O_m$ with $V(G)$ and $E(G)$ as defined in Lemma 1. Let f be a local antimagic labeling of G . We first observe that $w(u_i^k) = f(v_i u_i^k)$, $w(v_i) = f(cv_i)$ are mutually distinct and at most q . Thus, f must induce $m(n+1)$ distinct colors, namely $w_1, w_2, \dots, w_{m(n+1)}$.

The minimum possible weight of the central vertex c is $w(c) \geq \frac{(m+n)(m+n+1)}{2} > q$. Hence, the central vertex c receives a new color $w_{m(n+1)+1}$.

Without loss of generality, we consider the following three cases.

Case 1. $f(v_1 v_2) = q$. In this case, $w(v_1) \neq w(v_2) \neq w(c) > q$. Hence, v_1, v_2 receive new colors $w_{m(n+1)+2}$ and $w_{m(n+1)+3}$. Thus, $\chi_{la}(G) \geq m(n+1) + 3$.

Case 2. $f(v_1 u_1^1) = q$. Now, $w(v_1) > q \neq w(c)$ so that v_1 receives a new color, say $w_{m(n+1)+2}$. Therefore, $\chi_{la}(G) \geq m(n+1) + 2$. Suppose equality holds. We must have $w(v_2), w(v_n) \leq q$. Moreover, $w(v_i)$ ($2 \leq i \leq n$) equals to a non-adjacent pendant vertex label, or else, $w(v_i) = w(v_1)$ for $3 \leq i \leq n-1$ such that for $3 \leq i \leq n-2$, not both $w(v_i)$ and $w(v_{i+1}) > q$, otherwise, f induces $m(n+1) + 3$ distinct colors. Let r be the number of vertices in $\{v_i: 1 \leq i \leq n\}$ with color $w(v_1)$. Observe that there are $n-r \geq n/2 \geq 2$ vertices with color at most q . Note that all these vertices are incident to at least $(m+1)(n-r) + n$ edges. Therefore, their labels sum under f is at most $(n-r)q$. However, the sum is at least $1 + 2 + \dots + [(m+1)(n-r) + n] = \frac{1}{2}[(m+1)(n-r) + n][(m+1)(n-r) + n + 1] = s$. Now,

$$\begin{aligned} & 2s - 2(n-r)q \\ &= [(m+1)(n-r) + n]^2 + [(m+1)(n-r) + n] - 2(n-r)(m(n+1) + 2n) \\ &= (m+1)^2(n-r)^2 + n^2 + (m+1)(n-r)(2n+1) + n - 2(n-r)(mn+m+2n) \\ &= (m+1)^2(n-r)^2 + n^2 - (n-r)(m+2n-1) > 0, \end{aligned}$$

contradicting $s \leq (n-r)q$. Thus, $\chi_{la}(G) \geq m(n+1) + 3$.

Case 3. $f(cv_1) = q$. Now, $w(v_1) > q \neq w(c)$ so that v_1 receives a new color, say $w_{m(n+1)+2}$. Therefore, $\chi_{la}(G) \geq m(n+1) + 2$. Suppose equality holds. We must have $w(v_2), w(v_n) < q$. By an argument similar to that in Case 2, we also reach the same contradiction. Thus, $\chi_{la}(G) \geq m(n+1) + 3$.

Assume $\chi_{la}(G) = m(n+1) + 3$. Suppose there is a vertex $v \in \{v_i: 1 \leq i \leq n\}$ with $w(v) \leq q = m(n+1) + 2n$. Clearly, $w(v) \geq 1 + 2 + \dots + (m+3) = (m+3)(m+4)/2$. Thus, $(m+3)(m+4) \leq 2m(n+1) + 4n$ so that $2n(m+2) \geq m^2 + 5m + 12 = (m+2)(m+3) + 6$ which implies that $2n \geq (m+3) + 6/(m+2) > m+3$. Therefore, $m < 2n - 3$. Consequently, $\chi_{la}(G) \geq m(n+1) + 4$ if $m \geq 2n - 3$. \square

Theorem 3. For $n \geq 5$ is odd, $\chi_{la}(W_n \circ O_m) = m(n+1) + 3$ if $m \leq 2n - 4$.

Proof. Let $G \cong W_n \circ O_m$ with $V(G)$ and $E(G)$ as defined in Lemma 1. By Lemma 2, we only need to give a local antimagic labeling of G that induces $m(n+1) + 3$ distinct colors for $m \leq 2n - 4$.

Case(1): $n \geq 5$ is odd and $m = 1$.

Subcase(i): $n = 5, 7, 9$ and $m = 1$:

$$f(cv_i) = \begin{cases} 1, & i = 1, \\ n+1+i, & 2 \leq i \leq n; \end{cases} \quad \text{c-set } \{n+3, n+4, \dots, 2n, 2n+1\},$$

$$f(v_i u_i^1) = \begin{cases} n+2, & i=1, \\ 3n+2-i, & 2 \leq i \leq n; \quad \text{c-set } \{3n, 3n-1, \dots, 2n+3, 2n+2\}, \end{cases}$$

$$f(v_i v_{i+1}) = \begin{cases} \frac{i+3}{2}, & i \text{ is odd, } 1 \leq i \leq n-2, \\ n+2-\frac{i}{2}, & i \text{ is even, } 2 \leq i \leq n-1; \quad \text{c-set } \left\{ n+1, n, \dots, \frac{n+7}{2}, \frac{n+5}{2} \right\}, \end{cases}$$

$$f(v_n v_1) = \frac{n+3}{2}.$$

Thus, the vertex weights are

$$w(v_i) = \begin{cases} \frac{3n+13}{2}, & i=1, \\ 5n+6, & i \text{ is even,} \\ 5n+7, & i \text{ is odd,} \end{cases} \quad w(c) = \frac{n(3n+7)}{2}, \quad w(u_i^1) = f(v_i u_i^1), \quad 1 \leq i \leq n.$$

Subcase(ii): $n \geq 11$ is odd and $m = 1$:

$$f(cv_i) = \begin{cases} 1, & i=1, \\ 3n+2-i, & 2 \leq i \leq n; \quad \text{c-set } \{3n, 3n-1, \dots, 2n+3, 2n+2\}, \end{cases}$$

$$f(v_i u_i^1) = n+i+1, \quad 1 \leq i \leq n; \quad \text{c-set } \{n+2, n+3, \dots, 2n, 2n+1\},$$

$$f(v_i v_{i+1}) = \begin{cases} \frac{i+3}{2}, & i \text{ is odd, } 1 \leq i \leq n-2; \quad \text{c-set } \left\{ 2, 3, \dots, \frac{n-1}{2}, \frac{n+1}{2} \right\}, \\ n+2-\frac{i}{2}, & i \text{ is even, } 2 \leq i \leq n-1; \quad \text{c-set } \left\{ n+1, n, \dots, \frac{n+7}{2}, \frac{n+5}{2} \right\}, \end{cases}$$

$$f(v_n v_1) = \frac{n+3}{2}.$$

Thus, the vertex weights are

$$w(v_i) = \begin{cases} \frac{3n+13}{2}, & i=1, \\ 5n+6, & i \text{ is even,} \\ 5n+7, & i \text{ is odd,} \end{cases} \quad w(c) = \frac{n(5n+3)+2}{2}, \quad w(u_i^1) = f(v_i u_i^1), \quad 1 \leq i \leq n.$$

Case(1): $m \geq 3$ is odd.

Now, we define the function $f: E(G) \rightarrow \{1, 2, 3, \dots, |E(G)| = 2n + m(n+1)\}$ by

$$f(cv_i) = \begin{cases} 1, & i=1, \\ m+n+i, & 2 \leq i \leq n; \\ \text{c-set } \{m+n+2, m+n+3, \dots, m+2n-1, m+2n\}, \end{cases}$$

$$f(v_i v_{i+1}) = \begin{cases} m+1+\frac{i+1}{2}, & i \text{ is odd, } 1 \leq i \leq n-2; \\ m+n+2-\frac{i}{2}, & i \text{ is even, } 1 \leq i \leq n-3; \\ \text{c-set } \left\{ m+2, m+3, \dots, m+\frac{n-1}{2}, m+\frac{n+1}{2} \right\}, \\ \text{c-set } \left\{ m+n+1, m+n, \dots, m+\frac{n+7}{2}, m+\frac{n+5}{2} \right\}, \end{cases}$$

$$\begin{aligned}
 f(v_n v_1) &= m + \frac{n+3}{2}, \\
 f(v_i u_i^k) &= \begin{cases} k+1, & i=1, \quad 1 \leq k \leq m; \\ m+2n+(n-1)k-(i-2), & 2 \leq i \leq n, \quad k \text{ is odd}; \\ m+2n+(n-1)(k-1)+i-1, & 2 \leq i < n, \quad k \text{ is even}; \end{cases} \\
 &\quad \begin{matrix} \text{c-set } \{2, 3, \dots, m, m+1\}, \\ \text{c-set is given in Table 9,} \\ \text{c-set is given in Table 10,} \end{matrix} \\
 f(cu^k) &= mn+2n+k, \quad 1 \leq k \leq m; \\
 &\quad \text{c-set } \{mn+2n+1, mn+2n+2, \dots, mn+2n+m\}.
 \end{aligned}$$

Table 9: n is odd, $2 \leq i \leq n$, $m \geq 3$ is odd, k is odd, $1 \leq k \leq m$

$v_2 u_2^k$	$v_3 u_3^k$...	$v_{n-1} u_{n-1}^k$	$v_n u_n^k$	k
$m+3n-1$	$m+3n-2$...	$m+2n+2$	$m+2n+1$	1
$m+5n-3$	$m+5n-5$...	$m+4n$	$m+4n-1$	3
\vdots	\vdots	\vdots	...	\vdots	\vdots
$mn+2n$	$mn+2n-1$...	$mn+n+3$	$mn+n+2$	m

Table 10: n is odd, $2 \leq i \leq n$, $m \geq 3$ is odd, k is even, $1 \leq k \leq m-1$

$v_2 u_2^k$	$v_3 u_3^k$...	$v_{n-1} u_{n-1}^k$	$v_n u_n^k$	k
$m+3n$	$m+3n+1$...	$m+4n-3$	$m+4n-2$	2
$m+5n-2$	$m+5n-1$...	$m+5n-4$	$m+5n-3$	4
\vdots	\vdots	\vdots	...	\vdots	\vdots
$mn+3$	$mn+4$...	$mn+n$	$mn+n+1$	$m-1$

Then, the vertex weights are

$$\begin{aligned}
 w(c) &= \frac{n(3n-1) + m(6n-1) + m^2(2n+1)}{2}, \\
 w(v_i) &= \begin{cases} \frac{m(m+7) + n+9}{2}, & i=1, \\ \frac{2m^2(n+1) + 2m(4n+7) + 2(5n+8)}{4}, & i \text{ is even}, \\ \frac{2m^2(n+1) + 2m(4n+7) + 10(n+2)}{4}, & i \text{ is odd}, \end{cases} \\
 w(u_i^k) &= f(v_i u_i^k), \quad 1 \leq i \leq n, \quad 1 \leq k \leq m, \\
 w(u^k) &= f(cu^k), \quad 1 \leq k \leq m,
 \end{aligned}$$

Hence, $\chi_{la}(W_n \circ O_m) \leq m(n+1) + 3$.

Case(2): m is even.

Now, we define the function $f: E(G) \rightarrow \{1, 2, 3, \dots, |E(G)| = 2n + m(n+1)\}$ by

$$f(cv_i) = \begin{cases} 1, & i=1, \\ m+2n+2-i, & 2 \leq i \leq n; \end{cases} \quad \text{c-set } \{m+2n, m+2n-1, \dots, m+n+3, m+n+2\},$$

$$f(v_i v_{i+1}) = \begin{cases} \frac{2m+i+3}{2}, & i \text{ is odd, } 1 \leq i \leq n-2; \\ \text{c-set } \left\{ m+2, m+3, \dots, m+\frac{n-1}{2}, m+\frac{n+1}{2} \right\}, & \\ \frac{2m+n+i+3}{2}, & i \text{ is even, } 2 \leq i \leq n-1; \\ \text{c-set } \left\{ m+\frac{n+5}{2}, m+\frac{n+7}{2}, \dots, m+n, m+n+1 \right\}, & \end{cases}$$

$$f(v_n v_1) = \frac{2m+n+3}{2}; \quad \text{c-set } \left\{ m+\frac{n+3}{2} \right\},$$

$$f(v_i u_i^k) = \begin{cases} k+1, & i=1, \quad 1 \leq k \leq m; \quad \text{c-set } \{2, 3, \dots, m, m+1\}, \\ \frac{4n+2m+i}{2}, & i \text{ is even, } 2 \leq i \leq n-1, \quad k=1; \quad \text{c-set } S_1, \\ \frac{6n+2m-i}{2}, & i \text{ is even, } 2 \leq i \leq n-1, \quad k=2; \quad \text{c-set } S_2, \\ \frac{6n+2m+i-3}{2}, & i \text{ is odd, } 3 \leq i \leq n, \quad k=1; \quad \text{c-set } S_3, \\ \frac{8n+2m-i-1}{2}, & i \text{ is odd, } 3 \leq i \leq n, \quad k=2; \quad \text{c-set } S_4, \\ n+m+k(n-1)+i, & 2 \leq i \leq n, \quad k \text{ is odd, } 3 \leq k \leq m-1; \\ & \text{c-set is given in Table 11,} \\ 2n+m+k(n-1)-i+2, & 2 \leq i \leq n, \quad k \text{ is even, } 4 \leq k \leq m; \\ & \text{c-set is given in Table 12,} \end{cases}$$

$$f(cu^k) = n(m+2) + k, \quad 1 \leq k \leq m;$$

$$\text{c-set } \{mn+2n+1, mn+2n+2, \dots, mn+2n+m\},$$

where

$$S_1 = \left\{ m+2n+1, m+2n+2, \dots, m+2n+\frac{n-3}{2}, m+2n+\frac{n-1}{2} \right\},$$

$$S_2 = \left\{ m+3n-1, m+3n-2, \dots, m+3n-\frac{n-3}{2}, m+3n-\frac{n-1}{2} \right\},$$

$$S_3 = \left\{ m+3n, m+3n+1, \dots, m+3n+\frac{n-5}{2}, m+3n+\frac{n-3}{2} \right\},$$

$$S_4 = \left\{ m+4n-2, m+4n-3, \dots, m+4n-\frac{n-1}{2}, m+4n-\frac{n+1}{2} \right\}.$$

Table 11: n is odd, $2 \leq i \leq n$, $m \geq 3$ is even, k is odd, $1 \leq k \leq m-1$

$v_2 u_2^k$	$v_3 u_3^k$...	$v_{n-1} u_{n-1}^k$	$v_n u_n^k$	k
$m+4n-1$	$m+4n$...	$m+5n+4$	$m+5n-3$	3
$m+6n-3$	$m+6n-2$...	$m+7n-6$	$m+7n-5$	5
\vdots	\vdots	\vdots	...	\vdots	\vdots
$mn+3$	$mn+4$...	$mn+n-1$	$mn+n+1$	$m-1$

Table 12: n is odd, $2 \leq i \leq n$, $m \geq 3$ is even, k is even, $4 \leq k \leq m$

$v_2u_2^k$	$v_3u_3^k$	\dots	$v_{n-1}u_{n-1}^k$	$v_nu_n^k$	k
$m + 6n - 4$	$m + 6n - 5$	\dots	$m + 5n - 1$	$m + 5n - 2$	4
$m + 8n - 6$	$m + 8n - 7$	\dots	$m + 7n - 3$	$m + 7n - 4$	6
\vdots	\vdots	\vdots	\dots	\vdots	\vdots
$mn + 2n$	$mn + 2n - 1$	\dots	$mn + n + 1$	$mn + n + 2$	m

Thus, the vertex weights are

$$w(c) = \frac{m^2(2n + 1) + m(6n - 1) + n(3n - 1)}{2},$$

$$w(v_i) = \begin{cases} \frac{m(m + 7) + n + 9}{2}, & i = 1, \\ \frac{m^2(n + 1) + m(4n + 7) + 3n + 11}{2}, & i \text{ is even, } 2 \leq i \leq n - 1, \\ \frac{m^2(n + 1) + m(4n + 7) + 7(n + 1)}{2}, & i \text{ is odd, } 3 \leq i \leq n, \end{cases}$$

$$w(u_i^k) = f(v_iu_i^k), \quad 1 \leq i \leq n, \quad 1 \leq k \leq m,$$

$$w(u^k) = f(cu^k), \quad 1 \leq k \leq m.$$

Therefore, the labeling function f admits a local antimagic labeling of $W_n \circ O_m$ with $m(n + 1) + 3$ distinct induced colors. □

Example 2. Figures 3 and 4 show the labelings as given in the proof above.

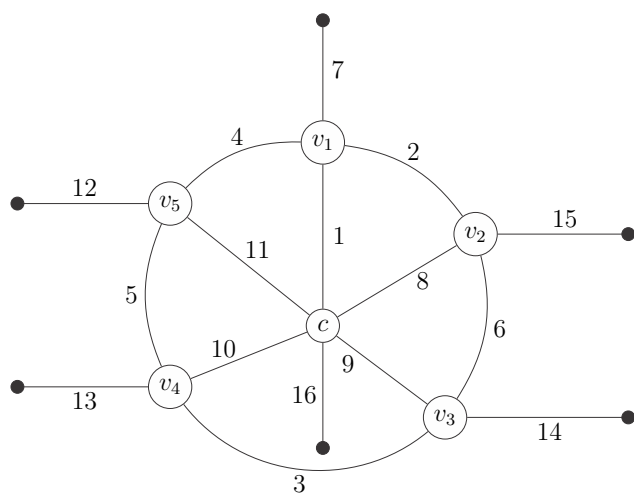

Figure 3: $\chi_{la}(W_5 \circ O_1) = 9$

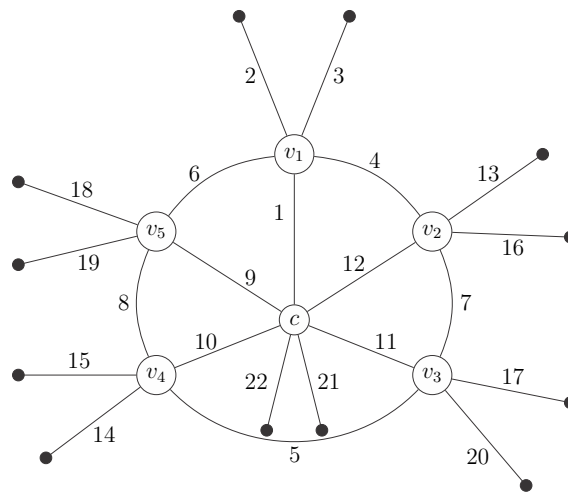

Figure 4: $\chi_{la}(W_5 \circ O_2) = 15$

Theorem 4. For $n \geq 5$ is odd, then $\chi_{la}(W_n \circ O_m) = m(n + 1) + 4$ if $m \geq 2n - 3$.

P r o o f. Let $G \cong W_n \circ O_m$ and let $V(G) = \{c \cup v_i \cup u_i^k \cup u^k, 1 \leq i \leq n, 1 \leq k \leq m\}$ and $E(G) = \{cv_i \cup v_iv_{i+1} \cup v_nv_1 \cup v_iv_i^k \cup cu^k, 1 \leq i \leq n, 1 \leq k \leq m\}$. Then $|V(G)| = (n + 1)(m + 1)$ and $|E(G)| = 2n + m(n + 1)$.

Suppose $\chi_{la}(W_n \circ O_m) = m(n + 1) + 4$. From Lemma 2, we get $m \geq 2n - 3$. So, for proving $\chi_{la}(W_n \circ O_m) = m(n + 1) + 4$, if $m \geq (2n - 3)$ it suffices to provide a local antimagic labeling

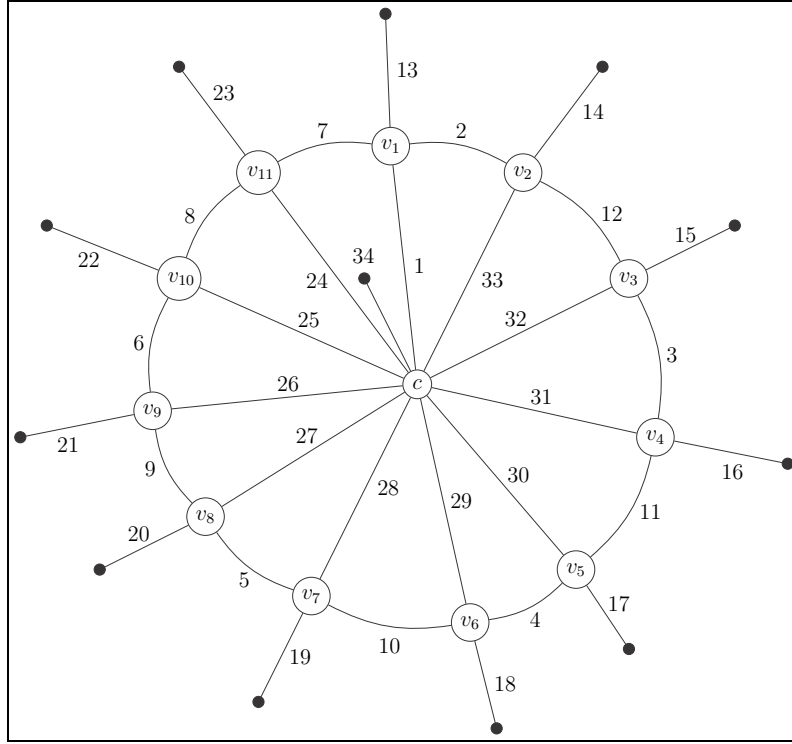

Figure 5: $\chi_{la}(W_{11} \circ O_1) = 15$

of $W_n \circ O_m$ that induces a local antimagic vertex coloring using exactly $m(n + 1) + 4$ colors. Now, we define the function $f: E(G) \rightarrow \{1, 2, 3, \dots, |E(G)| = 2n + m(n + 1)\}$ by

Case (1): m is odd, $m \geq 2n - 3$.

$$f(v_i u_i^k) = \begin{cases} \frac{5n - i + 2}{2}, & i \text{ is odd, } k = 1, 1 \leq i \leq n - 2; \text{ c-set } A_1, \\ \frac{6n - i + 4}{2}, & i \text{ is even, } k = 1, 2 \leq i \leq n - 1; \text{ c-set } A_2, \\ \frac{5n + 3}{2}, & i = n, k = 1; \text{ c-set } \{2n + \frac{n+3}{2}\}, \\ \frac{n(k+4) - k + i + 5}{2}, & i \text{ is odd, } k \text{ is even, } 1 \leq i \leq n - 2, \\ & 2 \leq k \leq m - 1; \text{ c-set is given in Table 13,} \\ \frac{n(k+5) - k - i + 4}{2}, & i \text{ is odd, } k \text{ is odd, } 1 \leq i \leq n - 2, \\ & 3 \leq k \leq m; \text{ c-set is given in Table 14,} \\ \frac{6n + (n - 1)(m + k - 3) + i + 2}{2}, & i \text{ is even, } k \text{ is even, } 2 \leq i \leq n - 1, \\ & 2 \leq k \leq m - 1; \text{ c-set is given in Table 15,} \\ \frac{6n + (n - 1)(m + k - 2) - i + 4}{2}, & i \text{ is even, } k \text{ is odd, } 2 \leq i \leq n - 1, \\ & 3 \leq k \leq m; \text{ c-set is given in Table 16,} \\ 2n + m(n - 1) + k + 1, & i = n, 2 \leq k \leq m; \text{ c-set } A_3, \end{cases}$$

$$\begin{aligned}
 f(cv_i) &= \begin{cases} \frac{n+2-i}{2}, & i \text{ is odd;} \\ \frac{2n-i+2}{2}, & i \text{ is even, } 1 \leq i \leq n-1; \end{cases} \\
 &\quad \text{c-set } \left\{ \frac{n+1}{2}, \frac{n-1}{2}, \dots, 2, 1 \right\}, \\
 &\quad \text{c-set } \left\{ n, n-1, \dots, \frac{n+5}{2}, \frac{n+3}{2} \right\}, \\
 f(v_i v_{i+1}) &= \begin{cases} \frac{2n+i+3}{2}, & i \text{ is odd, } 1 \leq i \leq n-2; \\ \frac{3n+i+3}{2}, & i \text{ is even, } 2 \leq i \leq n-1; \end{cases} \\
 &\quad \text{c-set } \left\{ n+2, n+3, \dots, n+\frac{n-1}{2}, n+\frac{n+1}{2} \right\}, \\
 &\quad \text{c-set } \left\{ n+\frac{n+5}{2}, n+\frac{n+7}{2}, \dots, 2n, 2n+1 \right\}, \\
 f(v_n v_1) &= \frac{3n+3}{2}; \quad \text{c-set } \left\{ n+\frac{n+3}{2} \right\}, \\
 f(cu^k) &= \begin{cases} n+1, & k=1, \\ n(m+2)+k, & 2 \leq k \leq m; \end{cases} \\
 &\quad \text{c-set } \{mn+2n+2, mn+2n+3, \dots, mn+2n+m\},
 \end{aligned}$$

where

$$\begin{aligned}
 A_1 &= \left\{ 2n+\frac{n+1}{2}, 2n+\frac{n-1}{2}, \dots, 2n+3, 2n+2 \right\}, \\
 A_2 &= \left\{ 3n+1, 3n, \dots, 2n+\frac{n+7}{2}, 2n+\frac{n+5}{2} \right\}, \\
 A_3 &= \{m(n-1)+2n+3, m(n-1)+2n+4, \dots, mn+2n, mn+2n+1\}.
 \end{aligned}$$

Table 13: n is odd, i is odd, $1 \leq i \leq n-2$, $m \geq 3$ is odd, k is even, $2 \leq k \leq m-1$

$v_1 u_1^k$	$v_3 u_3^k$...	$v_{n-4} u_{n-4}^k$	$v_{n-2} u_{n-2}^k$	k
$3n+2$	$3n+3$...	$3n+\frac{n-1}{2}$	$3n+\frac{n+1}{2}$	2
$4n+1$	$4n+2$...	$4n+\frac{n-3}{2}$	$4n+\frac{n-1}{2}$	4
\vdots	\vdots	...	\vdots	\vdots	\vdots
$\frac{m(n-1)+3n+7}{2}$	$\frac{m(n-1)+3n+9}{2}$...	$\frac{m(n-1)}{2}+2n+1$	$\frac{m(n-1)}{2}+2n+2$	$m-1$

Table 14: n is odd, i is odd, $1 \leq i \leq n - 2$, $m \geq 3$ is odd, k is odd, $3 \leq k \leq m$

$v_1u_1^k$	$v_3u_3^k$...	$v_{n-4}u_{n-4}^k$	$v_{n-2}u_{n-2}^k$	k
$4n$	$4n - 1$...	$3n + \frac{n+5}{2}$	$3n + \frac{n+3}{2}$	3
$5n - 1$	$5n - 2$...	$4n + \frac{n+3}{2}$	$4n + \frac{n+1}{2}$	5
\vdots	\vdots	...	\vdots	\vdots	\vdots
$\frac{m(n-1)}{2} + 2n + \frac{n+3}{2}$	$\frac{m(n-1)}{2} + 2n + \frac{n+1}{2}$...	$\frac{m(n-1)}{2} + 2n + 4$	$\frac{m(n-1)}{2} + 2n + 3$	m

Table 15: n is odd, i is even, $2 \leq i \leq n - 1$, $m \geq 3$ is odd, k is even, $2 \leq k \leq m - 1$

$v_2u_2^k$	$v_4u_4^k$...	$v_{n-3}u_{n-3}^k$	$v_{n-1}u_{n-1}^k$	k
$\frac{m(n-1)}{2} + 2n + \frac{n+5}{2}$	$\frac{m(n-1)}{2} + 2n + \frac{n+7}{2}$...	$\frac{m(n-1)}{2} + 3n$	$\frac{m(n-1)}{2} + 3n + 1$	2
$\frac{(n-1)(m+1)}{2} + 3n + 2$	$\frac{(n-1)(m+1)}{2} + 3n + 3$...	$\frac{(n-1)(m+2)}{2} + 3n$	$\frac{(n-1)(m+2)}{2} + 3n + 1$	4
\vdots	\vdots	...	\vdots	\vdots	\vdots
$(n-1)(m-2) + 3n + 2$	$(n-1)(m-2) + 3n + 3$...	$(n-1)(m-2) + \frac{7n-1}{2}$	$(n-1)(m-2) + \frac{7n+1}{2}$	$m-1$

Table 16: n is odd, i is even, $2 \leq i \leq n - 1$, $m \geq 3$ is odd, k is odd, $3 \leq k \leq m$

$v_2u_2^k$	$v_4u_4^k$...	$v_{n-3}u_{n-3}^k$	$v_{n-1}u_{n-1}^k$	k
$\frac{(n-1)(m+1)}{2} + 3n + 1$	$\frac{(n-1)(m+1)}{2} + 3n$...	$\frac{m(n-1)}{2} + 3n + 3$	$\frac{m(n-1)}{2} + 3n + 2$	3
$\frac{(n-1)(m+3)}{2} + 3n + 1$	$\frac{(n-1)(m+3)}{2} + 3n$...	$\frac{(n-1)(m+2)}{2} + 3n + 3$	$\frac{(n-1)(m+2)}{2} + 3n + 2$	5
\vdots	\vdots	...	\vdots	\vdots	\vdots
$m(n-1) + 2n + 2$	$m(n-1) + 2n + 1$...	$m(n-1) + \frac{3n+9}{2}$	$m(n-1) + \frac{3n+7}{2}$	m

Then, the vertex weights are

$$w(c) = \frac{n(2m^2 + 2m + n - 1) + m(m + 1)}{2}, \quad m \text{ is odd,}$$

$$w(v_i) = \begin{cases} \frac{mn(m + 10) - m(m - 8) + 11(n + 1)}{4}, & m \geq 3 \text{ is odd, } i \text{ is odd, } 1 \leq i \leq n - 2, \\ \frac{3mn(m + 2) - 3m(m - 4) + 17n + 13}{4}, & m \geq 3 \text{ is odd, } i \text{ is even, } 2 \leq i \leq n - 1, \\ \frac{m^2(2n - 1) + m(2n + 5) + 8n + 6}{2}, & i = n, \end{cases}$$

$$w(u_i^k) = f(v_iu_i^k),$$

$$w(u^k) = f(cu^k).$$

Thus, the labeling f admits local antimagic labeling of $W_n \circ O_m$ with $m(n + 1) + 4$ colors, for n is odd.

Case (2): m is even, $m \geq 2n - 3$.

For $n = 5$ and $m = 8$, we define a labeling f given in Figure 7. Then the vertex weights are $w(c) = 360, w(v_5) = 362, w(v_1) = w(v_3) = 231, w(v_2) = w(v_4) = 296$ and $w(u_i^k) \cup w(u^k) = \{6, 7, 13, 14, 15, \dots, 58\}$. Thus, $\chi_{la}(W_5 \circ O_8) \leq m(n + 1) + 4$. For $n \neq 5$ is odd, m is even, $m \geq 2n - 3 \neq 8$, we define a labeling f as follows:

$$\begin{aligned}
 f(cv_i) &= n - i + 1, & 1 \leq i \leq n; & \quad \text{c-set } \{n, n - 1, \dots, 2, 1\}, \\
 f(v_i v_{i+1}) &= n + 3 + i, & 1 \leq i \leq n - 1; & \quad \text{c-set } \{n + 4, n + 5, \dots, 2n + 1, 2n + 2\}, \\
 f(v_n v_1) &= n + 3, \\
 f(v_i u_i^k) &= \begin{cases} \frac{7n - i + 2}{2}, & k = 1, \quad i \text{ is odd}, \quad 1 \leq i \leq n - 2; \quad \text{c-set } B_1, \\ \frac{8n - i + 1}{2}, & k = 2, \quad i \text{ is odd}, \quad 1 \leq i \leq n - 2; \quad \text{c-set } B_2, \\ \frac{5n - i + 5}{2}, & k = 1, \quad i \text{ is even}, \quad 2 \leq i \leq n - 1; \quad \text{c-set } B_3, \\ \frac{6n - i + 4}{2}, & k = 2, \quad i \text{ is even}, \quad 2 \leq i \leq n - 1; \quad \text{c-set } B_4, \\ 4n + 1, & k = 1, \quad i = n, \\ 4n + 2, & k = 2, \quad i = n, \\ \frac{n(k + 5) - k + i + 8}{2}, & i \text{ is odd}, \quad k \text{ is odd}, \quad 1 \leq i \leq n - 2, \\ & 3 \leq k \leq m - 1; \quad \text{c-set is given in Table 17,} \\ \frac{n(k + 6) - k - i + 7}{2}, & i \text{ is odd}, \quad k \text{ is even}, \quad 1 \leq i \leq n - 2, \\ & 4 \leq k \leq m; \quad \text{c-set is given in Table 18,} \\ \frac{8n + (n - 1)(m + k - 5) + i + 4}{2}, & i \text{ is even}, \quad k \text{ is odd}, \quad 1 \leq i \leq n - 1, \\ & 3 \leq k \leq m - 1; \quad \text{c-set is given in Table 19,} \\ \frac{8n + (n - 1)(m + k - 4) - i + 6}{2}, & i \text{ is even}, \quad k \text{ is even}, \quad 1 \leq i \leq n - 1, \\ & 4 \leq k \leq m; \quad \text{c-set is given in Table 20,} \\ m(n - 1) + 2(n + 1) + k, & i = n, \quad 3 \leq k \leq m; \quad \text{c-set } B_5, \end{cases} \\
 f(cu^k) &= \begin{cases} n + k, & 1 \leq k \leq 2; \quad \text{c-set } \{n + 1, n + 2\}, \\ n(m + 2) + k, & 3 \leq k \leq m; \\ & \text{c-set } \{mn + 2n + 3, mn + 2n + 4, \dots, mn + 2n + m\}, \end{cases}
 \end{aligned}$$

where

$$\begin{aligned}
 B_1 &= \left\{ 3n + \frac{n + 1}{2}, 3n + \frac{n - 1}{2}, \dots, 3n + 3, 3n + 2 \right\}, \\
 B_2 &= \left\{ 4n, 4n - 1, \dots, 3n + \frac{n + 5}{2}, 3n + \frac{n + 3}{2} \right\}, \\
 B_3 &= \left\{ 2n + \frac{n + 3}{2}, 2n + \frac{n + 1}{2}, \dots, 2n + 4, 2n + 3 \right\}, \\
 B_4 &= \left\{ 3n + 1, 3n, \dots, 2n + \frac{n + 7}{2}, 2n + \frac{n + 5}{2} \right\}, \\
 B_5 &= \{m(n - 1) + 2n + 5, m(n - 1) + 2n + 6, \dots, mn + 2n + 1, mn + 2n + 2\}.
 \end{aligned}$$

Table 17: n is odd, i is odd, $1 \leq i \leq n - 2$, $m \geq 3$ is even, k is odd, $3 \leq k \leq m - 1$

$v_1 u_1^k$	$v_3 u_3^k$...	$v_{n-4} u_{n-4}^k$	$v_{n-2} u_{n-2}^k$	k
$4n + 3$	$4n + 4$...	$4n + \frac{n+1}{2}$	$4n + \frac{n+3}{2}$	3
$5n + 2$	$5n + 3$...	$5n + \frac{n-1}{2}$	$5n + \frac{n+1}{2}$	5
\vdots	\vdots	...	\vdots	\vdots	\vdots
$\frac{m(n-1)}{2} + 2n + 5$	$\frac{m(n-1)}{2} + 2n + 7$...	$\frac{m(n-1)}{2} + \frac{5n+5}{2}$	$\frac{m(n-1)}{2} + \frac{5n+7}{2}$	$m-1$

Table 18: n is odd, i is odd, $1 \leq i \leq n - 2$, $m \geq 3$ is even, k is even, $4 \leq k \leq m$

$v_1 u_1^k$	$v_3 u_3^k$...	$v_{n-4} u_{n-4}^k$	$v_{n-2} u_{n-2}^k$	k
$5n + 1$	$5n$...	$4n + \frac{n+7}{2}$	$4n + \frac{n+5}{2}$	4
$6n$	$6n - 1$...	$5n + \frac{n+5}{2}$	$5n + \frac{n+3}{2}$	6
\vdots	\vdots	...	\vdots	\vdots	\vdots
$\frac{m(n-1)}{2} + 3n + 3$	$\frac{m(n-1)}{2} + 3n + 2$...	$\frac{m(n-1)}{2} + \frac{5n+11}{2}$	$\frac{m(n-1)}{2} + \frac{5n+9}{2}$	m

Table 19: n is odd, i is even, $2 \leq i \leq n - 1$, $m \geq 3$ is even, k is odd, $3 \leq k \leq m - 1$

$v_2 u_2^k$	$v_4 u_4^k$...	$v_{n-3} u_{n-3}^k$	$v_{n-1} u_{n-1}^k$	k
$\frac{m(n-1)}{2} + 3n + 4$	$\frac{m(n-1)}{2} + 3n + 5$...	$\frac{(n-1)(m-1)}{2} + 4n + 1$	$\frac{(n-1)(m-1)}{2} + 4n + 2$	3
$\frac{(n-1)m}{2} + 4n + 3$	$\frac{(n-1)m}{2} + 4n + 4$...	$\frac{(n-1)(m+1)}{2} + 4n + 1$	$\frac{(n-1)(m+1)}{2} + 4n + 2$	5
\vdots	\vdots	...	\vdots	\vdots	\vdots
$(n-1)(m-3) + 4n + 3$	$(n-1)(m-3) + 4n + 4$...	$(n-1)(m-3) + \frac{9n+1}{2}$	$(n-1)(m-3) + \frac{9n+3}{2}$	$m-1$

Table 20: n is odd, i is even, $2 \leq i \leq n - 1$, $m \geq 3$ is even, k is even, $4 \leq k \leq m$

$v_2 u_2^k$	$v_4 u_4^k$...	$v_{n-3} u_{n-3}^k$	$v_{n-1} u_{n-1}^k$	k
$\frac{m(n-1)}{2} + 4n + 2$	$\frac{m(n-1)}{2} + 4n + 1$...	$\frac{(n-1)(m-1)}{2} + 4n + 4$	$\frac{(n-1)(m-1)}{2} + 4n + 3$	4
$\frac{(n-1)(m+2)}{2} + 4n + 2$	$\frac{(n-1)(m+2)}{2} + 4n + 1$...	$\frac{(n-1)(m+1)}{2} + 4n + 4$	$\frac{(n-1)(m+1)}{2} + 4n + 3$	6
\vdots	\vdots	...	\vdots	\vdots	\vdots
$m(n-1) + 2n + 4$	$m(n-1) + 2n + 3$...	$(n-1)(m-2) + \frac{7n+9}{2}$	$(n-1)(m-2) + \frac{7n+7}{2}$	m

Thus, the vertex weights are

$$w(c) = \frac{n(n-3) + m(2mn + m + 1)}{2}, \quad m \text{ is even,}$$

$$w(v_i) = \begin{cases} \frac{m^2(n-1) + 2m(6n+7) + 2(7n+3)}{4}, & m \geq 4 \text{ is even, } i \text{ is odd, } 1 \leq i \leq n-2, \\ \frac{3m^2(n-1) + 2m(2n+11) + 2(7n+5)}{4}, & m \geq 4 \text{ is even, } i \text{ is even, } 2 \leq i \leq n-1, \\ \frac{m^2(2n-1) + 2(7n+2) + 9m}{2}, & m \geq 4 \text{ is even, } i = n, \end{cases}$$

$$w(u_i^k) = f(v_i u_i^k),$$

$$w(u^k) = f(cu^k).$$

Thus, the labeling f admits local antimagic labeling of $W_n \circ O_m$ with $m(n+1) + 4$ colors. \square

Example 3. Figure 6 shows the labeling of $W_5 \circ O_7$ given in the proof.

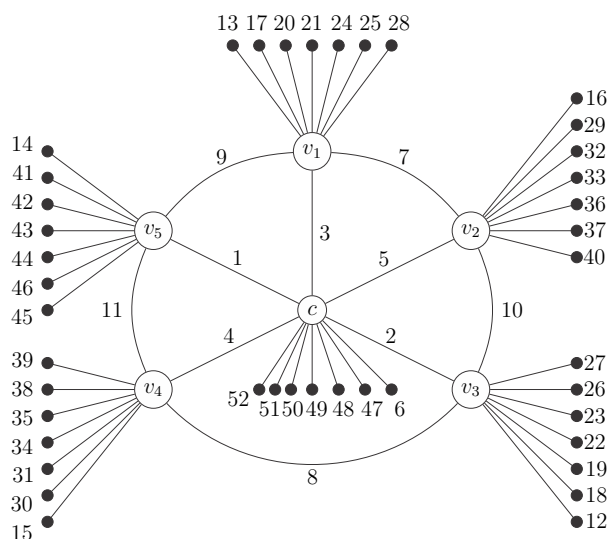

Figure 6: $\chi_{la}(W_5 \circ O_7) = 46$

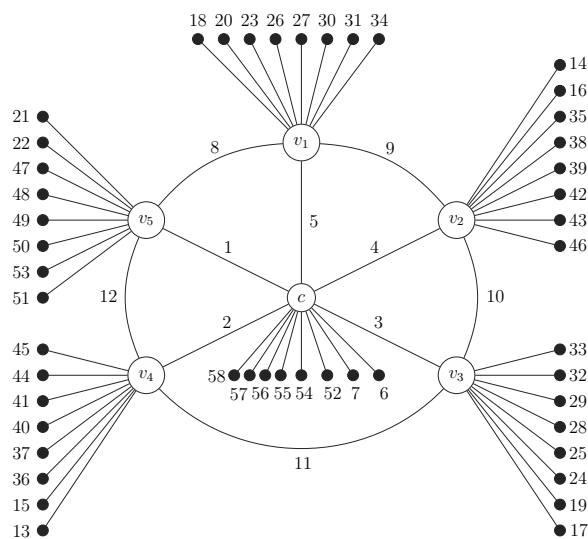

Figure 7: $\chi_{la}(W_5 \circ O_8) = 52$

Example 4. Figure 7 shows the labeling of $W_5 \circ O_8$ given in the proof.

§ 3. Conclusion

In this paper, we completely determined the local antimagic chromatic number for the corona product graph $W_n \circ O_m$, where $n \geq 3, m \geq 1$. In general, determining the local antimagic chromatic number for the corona product graph $G \circ O_m$ is too hard, where G is an arbitrary graph. The problem of determining the local antimagic chromatic number for the corona product of other new families of graphs with null graphs is very interesting to address in future work.

REFERENCES

1. Arumugam S., Premalatha K., Bacá M., Semaničová-Fečnovčíková A. Local antimagic vertex coloring of a graph, *Graphs and Combinatorics*, 2017, vol. 33, issue 2, pp. 275–285. <https://doi.org/10.1007/s00373-017-1758-7>

2. Premalatha K., Arumugam S., Lee Y.-Ch., Wang T.-M. Local antimagic chromatic number of trees — I, *Journal of Discrete Mathematical Sciences and Cryptography*, 2020. <https://doi.org/10.1080/09720529.2020.1772985>
3. Bensmail J., Senhaji M., Lyngsie K. S. On a combination of the 1-2-3 conjecture and the antimagic labeling conjecture, *Discrete Mathematics and Theoretical Computer Science*, 2017, vol. 19, no. 1, article 21. <https://doi.org/10.23638/DMTCS-19-1-21>
4. Chartrand G., Lesniak L., Zhang P. *Graphs and digraphs*, New York: Chapman and Hall/CRC, 2015. <https://doi.org/10.1201/b19731>
5. Eccles T. Graphs of large linear size are antimagic, *Journal of graph theory*, 2016, vol. 81, issue 3, pp. 236–261. <https://doi.org/10.1002/jgt.21872>
6. Gallian J. A. Graph labeling, *The Electronic Journal of Combinatorics*, 2021, issue Dynamic Surveys, DS6. <https://doi.org/10.37236/27>
7. Hartsfield N., Ringel G. *Pearls in graph theory: a comprehensive introduction*, Boston: Academic Press, 1990. https://archive.org/details/pearlsingraphthe00har_f6p/page/n5/mode/2up
8. Haslegrave J. Proof of a local antimagic conjecture, *Discrete Mathematics and Theoretical Computer Science*, 2018, vol. 20, no. 1, article 18. <https://doi.org/10.23638/DMTCS-20-1-18>
9. Lau G.-Ch., Ng H.-K., Shiu W.-Ch. Affirmative solutions on local antimagic chromatic number, *Graphs and Combinatorics*, 2020, vol. 36, issue 5, pp. 1337–1354. <https://doi.org/10.1007/s00373-020-02197-2>
10. Lau G.-Ch., Ng H.-K., Shiu W.-Ch. On local antimagic chromatic number of cycle-related join graphs, *Discussiones Mathematicae Graph Theory*, 2021, vol. 41, issue 1, pp. 133–152. <https://doi.org/10.7151/dmgt.2177>
11. Lau G.-Ch., Shiu W.-Ch., Ng H.-K. On local antimagic chromatic number of graphs with cut-vertices, *Iranian Journal of Mathematical Sciences and Informatics*, 2022. Accepted. <https://doi.org/10.48550/arXiv.1805.04801>
12. Liang Y.-Ch., Wong Ts.-L., Zhu X. Anti-magic labeling of trees, *Discrete Mathematics*, 2014, vol. 331, pp. 9–14. <https://doi.org/10.1016/j.disc.2014.04.021>
13. Nalliah M., Shankar R., Wang T.-M. Local antimagic vertex coloring for generalized friendship graphs, *Journal of Discrete Mathematical Sciences and Cryptography*, 2022. <https://doi.org/10.1080/09720529.2021.1974651>
14. Shaebani S. On local antimagic chromatic number of graphs, *Journal of Algebraic Systems*, 2020, vol. 7, issue 2, pp. 245–256. <https://doi.org/10.22044/JAS.2019.7933.1391>
15. Shankar R., Nalliah M. Local vertex antimagic chromatic number of some wheel related graphs, *Proyecciones*, 2022, vol. 41, no. 1, pp. 319–334. <https://doi.org/10.22199/issn.0717-6279-4420>

Received 12.05.2022

Accepted 03.08.2022

Rathinavel Shankar, Department of Mathematics, School of Advanced Sciences, Vellore Institute of Technology, VIT, Vellore Campus, Tiruvalam Rd, Katpadi, Vellore, Tamil Nadu, 632014, India.

E-mail: rathinavelshankar@gmail.com

Moviri Chettiar Nalliah, Department of Mathematics, School of Advanced Sciences, Vellore Institute of Technology, VIT, Vellore Campus, Tiruvalam Rd, Katpadi, Vellore, Tamil Nadu, 632014, India.

ORCID: <https://orcid.org/0000-0002-3927-2607>

E-mail: nalliahklu@gmail.com

Citation: R. Shankar, M. Ch. Nalliah. Local antimagic chromatic number for the corona product of wheel and null graphs, *Vestnik Udmurtskogo Universiteta. Matematika. Mekhanika. Komp'yuternye Nauki*, 2022, vol. 32, issue 3, pp. 463–485.

Р. Шанкар, М. Ч. Наллиа

Локальное антимагическое хроматическое число для коронного произведения колеса и пустого графа

Ключевые слова: локальная антимагическая маркировка, локальное антимагическое хроматическое число, коронное произведение, граф колеса.

УДК 519.1

DOI: [10.35634/vm220308](https://doi.org/10.35634/vm220308)

Пусть $G = (V, E)$ — граф порядка p и размера q , не имеющий изолированных вершин. Биекция $f: E \rightarrow \{1, 2, 3, \dots, q\}$ называется локально антимагической маркировкой, если для всех $uv \in E$ имеем $w(u) \neq w(v)$, вес $w(u) = \sum_{e \in E(u)} f(e)$, где $E(u)$ — множество ребер, инцидентных u . Граф G является локально антимагическим, если G имеет локально антимагическую маркировку. Локальное антимагическое хроматическое число $\chi_{la}(G)$ определяется как минимальное количество цветов, взятых по всем раскраскам G , индуцированным локальными антимагическими маркировками G . В данной работе мы полностью определяем локальное антимагическое хроматическое число для коронного произведения графа колеса и пустого графа.

СПИСОК ЛИТЕРАТУРЫ

1. Arumugam S., Premalatha K., Vacá M., Semaničová–Fecňovčíková A. Local antimagic vertex coloring of a graph // *Graphs and Combinatorics*. 2017. Vol. 33. Issue 2. P. 275–285. <https://doi.org/10.1007/s00373-017-1758-7>
2. Premalatha K., Arumugam S., Lee Y.-Ch., Wang T.-M. Local antimagic chromatic number of trees — I // *Journal of Discrete Mathematical Sciences and Cryptography*. 2020. <https://doi.org/10.1080/09720529.2020.1772985>
3. Bensmail J., Senhaji M., Lyngsie K. S. On a combination of the 1-2-3 conjecture and the antimagic labeling conjecture // *Discrete Mathematics and Theoretical Computer Science*. 2017. Vol. 19. No. 1. Article 21. <https://doi.org/10.23638/DMTCS-19-1-21>
4. Chartrand G., Lesniak L., Zhang P. *Graphs and digraphs*. New York: Chapman and Hall/CRC, 2015. <https://doi.org/10.1201/b19731>
5. Eccles T. Graphs of large linear size are antimagic // *Journal of Graph Theory*. 2016. Vol. 81. Issue 3. P. 236–261. <https://doi.org/10.1002/jgt.21872>
6. Gallian J. A. Graph labeling // *The Electronic Journal of Combinatorics*. 2021. Issue Dynamic Surveys. DS6. <https://doi.org/10.37236/27>
7. Hartsfield N., Ringel G. *Pearls in graph theory: a comprehensive introduction*. Boston: Academic Press, 1990. https://archive.org/details/pearlsingraphthe00har_f6p/page/n5/mode/2up
8. Haslegrave J. Proof of a local antimagic conjecture // *Discrete Mathematics and Theoretical Computer Science*. 2018. Vol. 20. No. 1. Article 18. <https://doi.org/10.23638/DMTCS-20-1-18>
9. Lau G.-Ch., Ng H.-K., Shiu W.-Ch. Affirmative solutions on local antimagic chromatic number // *Graphs and Combinatorics*. 2020. Vol. 36. Issue 5. P. 1337–1354. <https://doi.org/10.1007/s00373-020-02197-2>
10. Lau G.-Ch., Ng H.-K., Shiu W.-Ch. On local antimagic chromatic number of cycle-related join graphs // *Discussiones Mathematicae Graph Theory*. 2021. Vol. 41. Issue 1. P. 133–152. <https://doi.org/10.7151/dmgt.2177>
11. Lau G.-Ch., Shiu W.-Ch., Ng H.-K. On local antimagic chromatic number of graphs with cut-vertices // *Iranian Journal of Mathematical Sciences and Informatics*. 2022. Accepted. <https://doi.org/10.48550/arXiv.1805.04801>
12. Liang Y.-Ch., Wong Ts.-L., Zhu X. Anti-magic labeling of trees // *Discrete Mathematics*. 2014. Vol. 331. P. 9–14. <https://doi.org/10.1016/j.disc.2014.04.021>

13. Nalliah M., Shankar R., Wang T.-M. Local antimagic vertex coloring for generalized friendship graphs // *Journal of Discrete Mathematical Sciences and Cryptography*. 2022. <https://doi.org/10.1080/09720529.2021.1974651>
14. Shaebani S. On local antimagic chromatic number of graphs // *Journal of Algebraic Systems*. 2020. Vol. 7. Issue 2. P. 245–256. <https://doi.org/10.22044/JAS.2019.7933.1391>
15. Shankar R., Nalliah M. Local vertex antimagic chromatic number of some wheel related graphs // *Proyecciones*. 2022. Vol. 41. No. 1. P. 319–334. <https://doi.org/10.22199/issn.0717-6279-4420>

Поступила в редакцию 12.05.2022

Принята к публикации 03.08.2022

Шанкар Ратинавел, кафедра математики, школа передовых наук, Веллорский технологический институт, 632014, Индия, Тамилнад, Веллор.

E-mail: rathinavelshankar@gmail.com

Наллиа Мовири Четтиар, кафедра математики, школа передовых наук, Веллорский технологический институт, 632014, Индия, Тамилнад, Веллор.

ORCID: <https://orcid.org/0000-0002-3927-2607>

E-mail: nalliahklu@gmail.com

Цитирование: Р. Шанкар, М. Ч. Наллиа. Локальное антимагическое хроматическое число для коронного произведения колеса и пустого графа // *Вестник Удмуртского университета. Математика. Механика. Компьютерные науки*. 2022. Т. 32. Вып. 3. С. 463–485.